

PRO GROUP STAGE TRUSS&FLIGHT CASE CO., LTD.

Add: Dongtai Industry Zone,Shilian road,Shiji Town ,Panyu District Guangzhou,China

Post: 511450

Web: www.progrouptruss.com

Sales Dept.

Lisa yang

Mob:+86-139-2506-1556

Skype:xiaoqing4763

Email:lisa@progrouptruss.com

Product Manual

PRO GROUP STAGE TRUSS&FLIGHT CASE CO., LTD.



CONTENT

1. Company show	1-4
2. Flight case	5-10
3. Aluminum truss	11-18
4. Corner	19-20
5. Pillar system	21-22
6. Circle truss	23-24
7. A speaker truss	25-26
8. Project truss	27-28
9. Truss accesseries(PIPE)	29-30
10. scaffolding	31-32
11. Aluminum Stage	33-36
12. Workbench /Crow barrier	37-38
13. light stand	39-40
14. Party Tent	41-42



Reliability



Creativity



win-win

Company Profile

Pro Group is all round group professional in producing truss ,stage ,flight case and rental service for kinds of show ,concert,project and event.

Pro Group Stage Truss&Flight Case Co., limited , it is an integrated company mainly targeting on stage equipment. completed process of design, engineering and sales come together. As Professional manufacturer of truss ,stage , flight case , truss stands and hardware products since 2008, with a well qualified team , we are passionate about offering excellent products and the best solutions for our customers.

Through the past years 'development , We supply wide and diverse range of structure systems all over the world for entertainment industry ,especially get a pride achievement from Europe, India and Middle East etc.

Pro Group Stage&Truss :

Professional

All products is controlled under high quality by qualified engineer and skilled workshop men., providing safe, simple and easy-to-assemble solutions on a daily basis . Profound knowledge of construction processes and hands-on experience makes progrouppro expert in this field.

Reliable

We are committed to ensure you receive perfect products and tailored event solutions that bring exceptional results.

We provide professional design drawing ,SLW data, installation instruction .Every product would be test build on connection and safe loading weight before shipping to clients ,We ensure the quality and safety and the process, planning and execution is implemented with ease and fluency for our clients.

Our Vision:

To be a high valued pro entertainment event management company in market. expert on pro resource to create value via businesses

we endeavour for product excellence and continuous product innovation .

customers' satisfaction is our persuit, we are ready to light up our future



*heavy-duty truss system (14+14)x24xH10M
6 pillars 3 cross beams.
600x760mm as beam / 450x450mm as pillar
loading and test building before shipping*



Trust comes from profession, Profession comes from safety and celerity

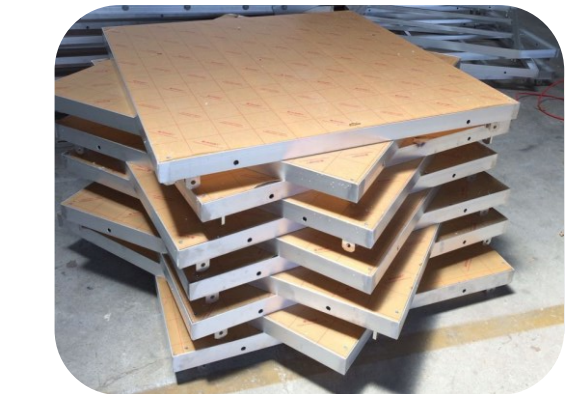
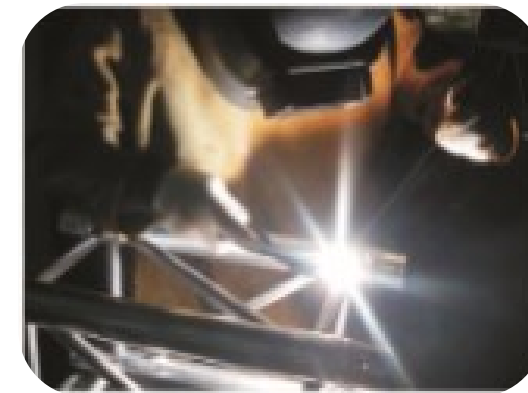
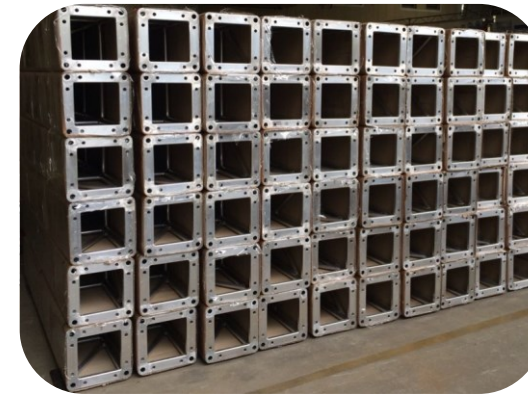



FC18U

Standard U case



Pro Group has its own workshop to manufacture kinds of flight cases and accessories on market need. Standard u case and customized case for light,sound ,mixer and so on .We have advanced machine, professional engineer to design all kinds of cases accordingly to customers' need.

Standard U case ,Shockproof and non-shockproof for choose.. nomally 9mm plywood+1mm fireproof plywood(both sides) , lighter material available.

Picture	Model	Size(WXDXHmm)	Weight
	2U	530x516x130mm	6.8kgs
	4U	530x516x220mm	11kgs
	6U	530x516x300mm	15.1kgs
	8U	530x516x390mm	19.2kgs
	10U	530x516x480mm with wheels	23.3kgs
	12U	530x516x570mm with wheels	27.7kgs
	14U	530x516x660mm with wheels	31.6kgs
	16U	530x516x745mm with wheels	35.8kgs
	18U	530x516x835mm with wheels	39.1kgs
	20U	530x516x925mm with wheels	41.6kgs
	22U	530x516x1015mm with wheels	45.2kgs
	24U	530x516x1105mm with wheels	49.1kgs

FC15-01

Printer flight case



Size:	485X362X510mm
Description:	Printer flight case with rod
Material:	9mm plywood+1mm fireproof wood , EVA foam
Weight:	17kg
Applications:	Flight case for printer, Different customized case for equipment available

FC15-0801

TV case



Size:	1235X391X732mm (case outside size) ,each section size 1137x82xH673mm
Description:	LG 50LN540V TV case ,2pcs in one ,with wheels or 1pcs in one without wheels
Material:	9mm plywood+1mm fireproof wood , EVA foam
Weight:	17kg
Applications:	Flight case for TV , Different customized case for equipment available

FC15-0802

sound case



Size:	H1245x843x634mm
Description:	speaker + stand case (20sections)
Material:	9mm plywood+1mm fireproof wood , EVA foam
Applications:	speaker + stand case, Different customized case for equipment available

Different customized case available



Mixer and handle case









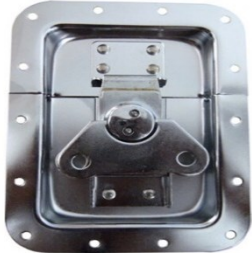

Sound and speaker case

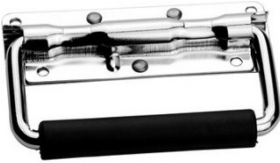

Lighting case

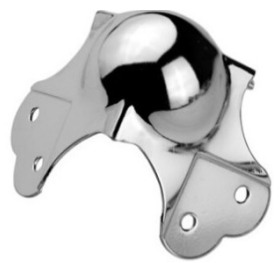

<p>PCA001</p> <p>Big lock/ big catch 174x127mm 1.2mm 500g Chrome plated</p> 	<p>PCA002A</p> <p>Medium lock 104x108mm 1.2mm 220g Chrome plated</p> 
<p>PCA002B</p> <p>spring lock 104x108mm 1.2mm 220g Chrome plated</p> 	<p>PCA003</p> <p>Simple lock 74x62mm 110g Chrome plated</p> 
<p>PCA004</p> <p>spring lock 104x108mm 1.2mm 220g Chrome plated</p> 	<p>PCA004A</p> <p>Simple handle 121x36mm 1.2mm 200g Chrome plated</p> 
<p>PCA005</p> <p>Castor (with lock or without lock) 3"</p> 	<p>PCA006</p> <p>Ball corner 64x64mm 1.5mm 100g Chrome plated</p> 
<p>PCA007</p> <p>Ball corner 64x64mm 1.5mm 100g Chrome plated</p> 	<p>PCA008</p> <p>4 holes corner brace 30x40mm 1.2mm 30g Chrome plated</p> 

<p>PCA009A</p> <p>6 holes corner brace (corner cut) 54x40mm 1.2mm 40g Chrome plated</p> 	<p>PCA009B</p> <p>6 holes corner brace 54x40mm 1.2mm 40g Chrome plated</p> 
<p>PCA010</p> <p>Castor dish/ wheel well 155x115x40mm 1mm Powder plating</p> 	<p>PCA011</p> <p>Hinge support 12holes 110x70mm 1.2mm Chrome plated</p> 
<p>PCA012</p> <p>radiator pannel/ ventilation dish 115x166mm 1.2mm 150g Chrome plated</p> 	<p>PCA013</p> <p>Rack strip 20x40 1.2mm 700g/m Powder plating</p> 
<p>PCA014</p> <p>1.5" hinge Length 1800mm 0.8mm 304 stainless steel</p> 	<p>PCA015</p> <p>9mm male and female aluminum 25*25mm</p> 
<p>PCA016</p> <p>Single angle 30x30mm 1.4mm Silver white</p> 	<p>PCA017</p> <p>bilateral aluminum angle 30x30mm Silver white</p> 
	<p>PCA018</p> <p>Extension bracket 165x26x3mm</p> 



Pro Group truss ,choose international high quality material aluminum 6082 T6.Certificated welding High quality control operatted during prodcutin .and All products is controlled under high quality by qualified engineer and skilled workshop men., providing safe, simple and easy-to-assemble solutions on a daily basis .

different size of truss meet with customers need , there is spigot and bolt type conection. OEM are warmly welcome.



Customers'project



PTR290

Triangular spigot truss

PTR300

Triangular bolt truss



Model:	PTR290	PTR300
Size:	290x290mm	300x300mm
Description:	triangular spigot truss	triangular bolt truss
Material:	6082 T6 aluminum alloy	
Color:	Silver , customized color like black ,blue, red color available	
Main tube:	50x3mm	
Support tube:	20x2mm	
Length available:	0.5m ,1m ,1.5m,2m ,2.5m,3m ,3.5m ,4m	
Span &SLW:	22kgs / *12m	
Applications:	kinds of Concert, project,outdoor and indoor performance and shows, Exhibitions etc	

PS290

Aluminum spigot truss

PB300

Aluminum screw truss



Model:	PS290	PB300
Size:	290x290mm	300x300mm
Description:	square spigot truss	square bolt truss
Material:	6082 T6 aluminum alloy	
Color:	Silver , customized color like black ,blue, red color available	
Main tube:	50x3mm	
Support tube:	20x2mm	25x2mm
Length available:	0.5m ,1m ,1.5m,2m ,2.5m,3m ,3.5m ,4m	
Span &SLW:	45kgs / *12m	50kgs / *12m
Applications:	kinds of concert, project, outdoor and indoor performance and shows, Exhibitions etc.	

PTR30 Allowable Loading

6082-T6 50*3mm tube as main tube 25*2mm as brace tube

Span	LOAD ALL	Uniformly distributed load(UDL)	Centre point load(CPL)	2 points	3 points	4 points	DEFLECTION
4	781.4	195.4	390.7	293	195.4	162.6	5
5	624.8	125	312.4	234.3	156.2	130	13
6	522.7	87.1	261.4	196	130.7	108.8	22
7	443.5	63.4	221.8	166.3	110.9	92.2	33
8	387.2	48.4	193.6	145.2	96.8	80.5	45
9	340.6	37.8	170.7	128	85.4	71.1	59
10	308	30.8	154	115.5	77	64	75
11	280.7	25.5	140.8	105.6	70.4	58.6	92
12	253.4	21.1	126.7	95	63.4	52.7	110

PB300 Allowable Loading

6082-T6 50*3mm tube as main tube 25*2mm as brace tube

Span	LOAD ALL	Uniformly distributed load(UDL)	Centre point load(CPL)	2 points	3 points	4 points	DEFLECTION
4	1155	289	462	347	231	192	5
5	924	185	462	347	231	192	11
6	924	154	462	347	231	192	17
7	924	132	462	347	231	192	31
8	901	113	451	338	225	187	52
9	800	89	400	300	200	167	68
10	722	72	361	271	180	150	87
11	658	60	329	247	165	137	108
12	602	50	301	226	150	125	130

PS390

Spigot truss 390X390mm



PB400

Screw truss 400X400mm



Model:	PS390	PB400
Size:	390x390mm	400x400mm
Description:	390X390mm square spigot truss	400x400mm square bolt truss
Material:	6082 T6 aluminum alloy	
Color:	Silver , customized color like black ,blue, red color available	
Main tube:	50x3mm	
Support tube:	30x2mm	
Length available:	0.5m ,1m ,1.5m,2m ,2.5m,3m ,3.5m ,4m	
Span &SLW:	42kgs / *16m	43.5kgs / *16m
Applications :	kinds of concert, project, outdoor and indoor performance and shows, exhibitions etc.	

PB400 Allowable Loading								
6082-T6 50*3mm tube as main tube 30*2mm as brace tube								
Span		LOAD ALL	UDL	CPL	2 points	3 points	4 points	DEFLECTION
m	(ft)	kg	kg/m	kg	kg	kg	kg	(mm)
4	13.1	932	232.8	465.6	349.2	232.8	193.7	3
5	16.4	932	186.4	465.6	349.2	232.8	193.7	4
6	19.7	931.2	155.2	465.6	349.2	232.8	193.7	7
7	23	929.6	132.8	464.8	348.6	232.4	193.4	9
8	26.2	928	116	464	348	232	193	18
9	29.5	928.8	103.2	464	348	232	193	22
10	32.8	928	92.8	464	348	232	193	40
11	36	925.5	84.8	464	348	232	193.3	54
12	39.2	921.6	76.8	460.8	345.6	230.4	191.7	73
13	42.6	852.8	65.6	426.4	319.2	213.2	177.4	89
14	45.9	795.2	56.8	397.6	297.6	198.8	165.4	107
15	49.2	744	49.6	372	278.4	186	154.7	123
16	52.5	691.2	47.5	345.6	259.2	172.8	138.7	140

PS450

Spigot truss 450X450mm



PB450

Screw truss 450X450mm



Model:	PS450	PB450
Size:	450x450mm	450x450mm
Description:	450x450mm square spigot truss	450x450mm square bolt truss
Material:	6082 T6 aluminum alloy	
Color:	Silver , customized color like black ,blue, red color available	
Main tube:	50x3mm	
Support tube:	30x2mm	
Length available :	0.5m ,1m ,1.5m,2m ,2.5m,3m ,3.5m ,4m	
Span &SLW:	45kgs / *18m	48.5kgs / *18m
Applications :	kinds of concert, project, outdoor and indoor performance and shows, Exhibitions etc.	

PB450 Allowable Loading								
6082-T6 50*3mm plus tube as main tube 30*2mm as brace tube								
Span		LOAD ALL	UDL	CPL	2 points	3 points	4 points	DEFLECTION
m	(ft)	kg	kg/m	kg	kg	kg	kg	(mm)
4	13.1	1212	303	607	457	304	252	3
5	16.4	1216	243	607	457	304	252	4
6	19.7	1216	202	607	457	304	252	7
7	23	1208	173	606	454	304	252	9
8	26.2	1212	152	606	454	304	252	18
9	29.5	1211	134	606	454	304	252	22
10	32.8	1202	120	606	454	304	252	40
11	36	1208	110	606	454	304	252	54
12	39.3	1191	99	601	451	300	250	73
13	42.6	1104	85	557	417	278	231	89
14	45.9	1024	74	519	388	259	216	107
15	49.2	960	64	486	363	243	201	123
16	52.5	899	56	451	339	224	180	140
18	59.1	871	48	421	315	195	152	158

PS520

spigot truss 520x520mm



PB520

Screw truss 520x520mm



Model:	PS520	PB520
Size:	520x520mm	520x520mm
Description:	square spigot truss	square bolt truss
Material:	6082 T6 aluminum alloy	
Color:	Silver , customized color like black ,blue, red color available	
Main tube:	50x3mm	
Support tube:	30x2mm	
Length available:	0.5m ,1m ,1.5m,2m ,2.5m,3m ,3.5m ,4m	
Span &SLW:	49kgs / *20m	52.15kgs / *20m
Applications:	kinds of concert,outdoor and indoor performance and shows, Exhibitions etc.	



PS5276 /6076

Spigot truss 520x760mm



PB5276/6076

Screw truss 520x760mm



Model:	PS5276/6076	PB5276/6076
Size:	520x7600mm /600x760mm	520x760mm /600x760mm
Description:	square spigot truss	square bolt truss
Material:	6082 T6 aluminum alloy	
Color:	Silver , customized color like black ,blue, red color available	
Main tube:	50x3mm	
Support tube:	30x2mm	
Length available:	0.5m ,1m ,1.5m,2m ,2.5m,3m ,3.5m ,4m	
Span &SLW:	35kgs / *24m(32kgs/*26m)	37.5kgs / *24m (36kgs/*26m)
Applications:	kinds of concert,outdoor and indoor performance and shows, exhibitions etc.	

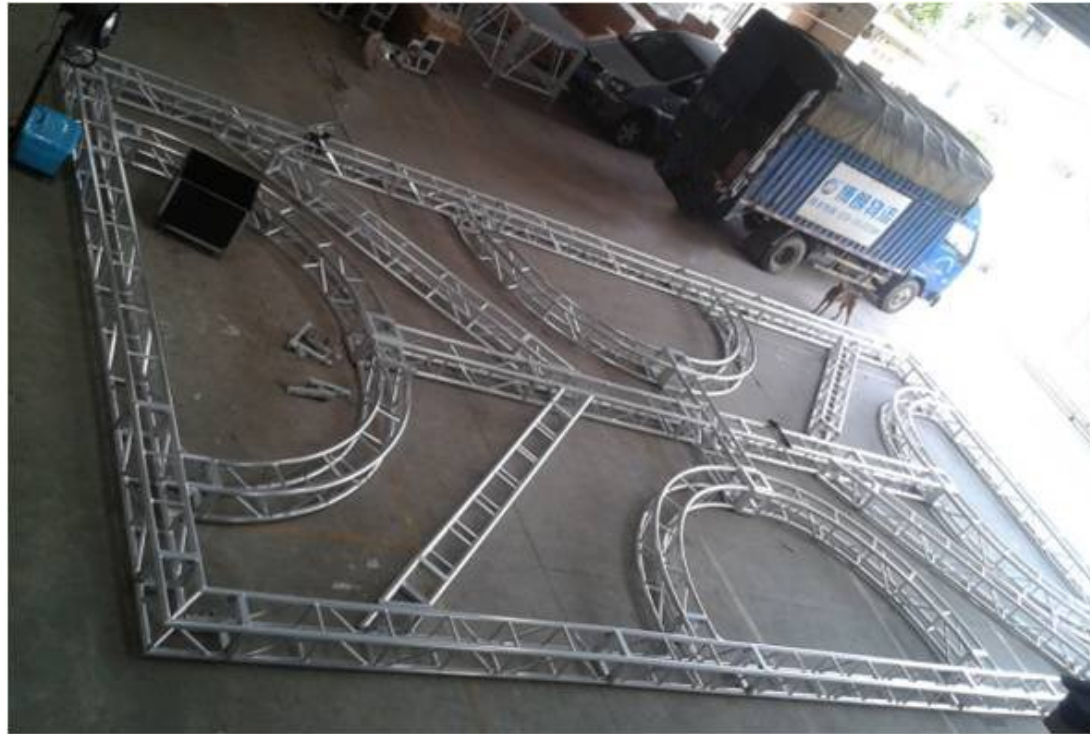

PS290-6Z
six way corner

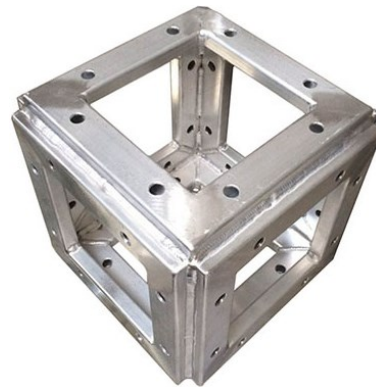
PB300-6Z
six way corner for screw truss

Model:	PS290-6Z	PB300-6Z
Description:	6 way corner (Pin type)	6 way corner (bolt type)
Size:	350*350mm (for 290*290mm truss)	350*350mm (for 300*300mm truss)

Square truss corner

 PS-2Z
two way corner

 PS-2Z1
two way corner 90°

 PS-3Z1
three way corner 90°

 PS-3Z
T type corner

 PS-4Z
four way corner

 PS-4Z1
Cross type corner

 PS-5Z
five way corner

 PS-LD10
aluminum plate

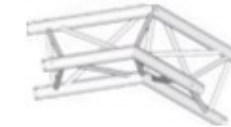
Triangular truss corner

 PTR-2Z
two way corner 60°/135°

 PTR-2Z1
two way corner 90°

 PTR-3Z1
three way corner

 PTR-3Z
T type corner

PTR-3Z three way corner



PTR-4Z1 cross type corner



PTR-5Z five way corner

 PTR-LD10
aluminum plate

Pillar system PL001

Ground support system

steel rope with clamp for insurance

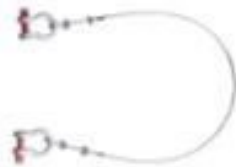

S001

Top section



Adjustable spigot



steel base with wheels



outrigger + stabilizer

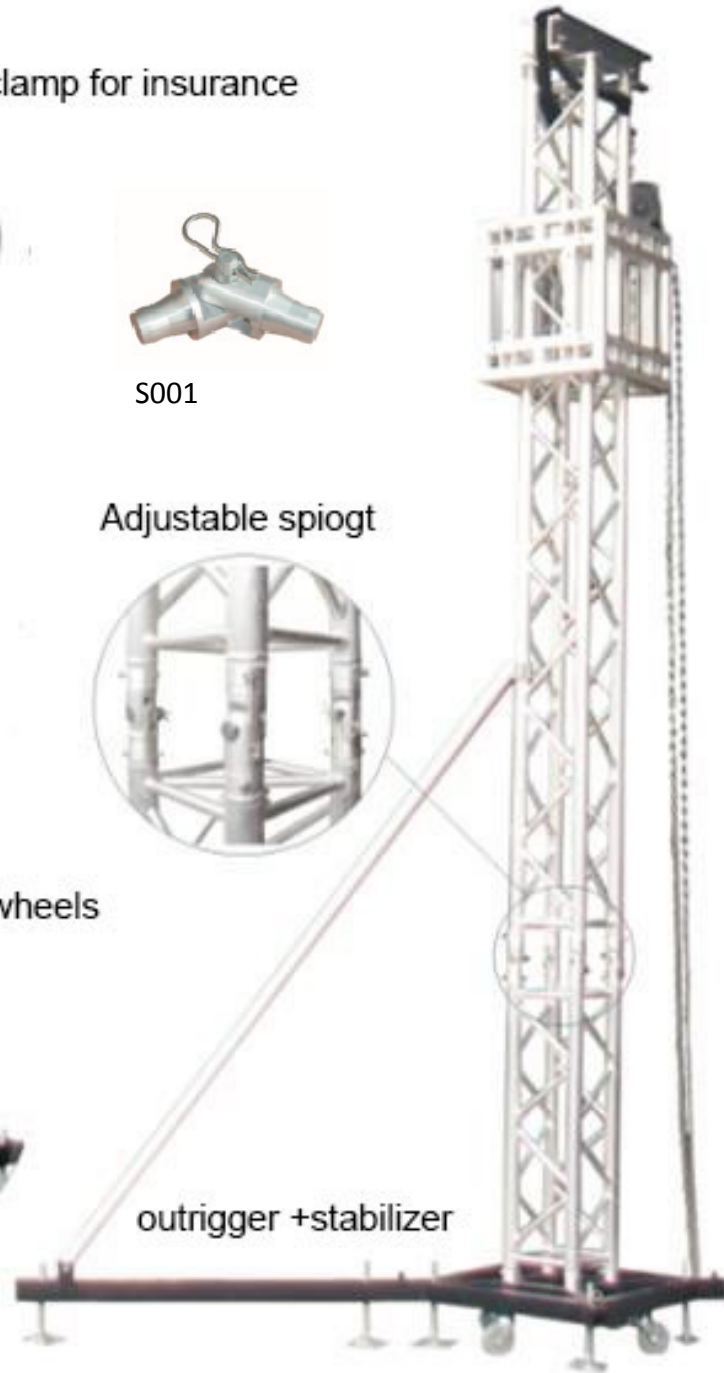

PTS-290 top section



PSB-290 sleeve block

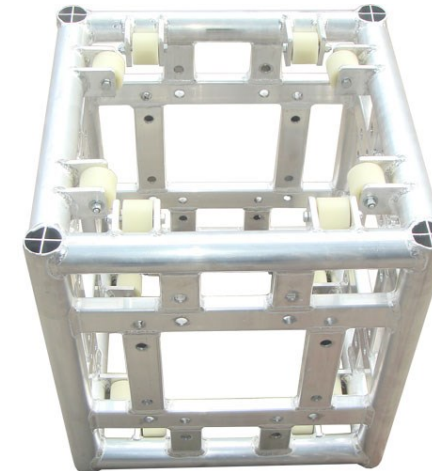

PBE-290 base with wheels



Cicle truss

Different shape truss

Different shows needs kinds of special circle truss that bring exceptional results,like circle truss, 's' shape truss ,arc truss , normally diameter from 3 to 12m. We could use different size ladder truss ,triangular and square truss to make .

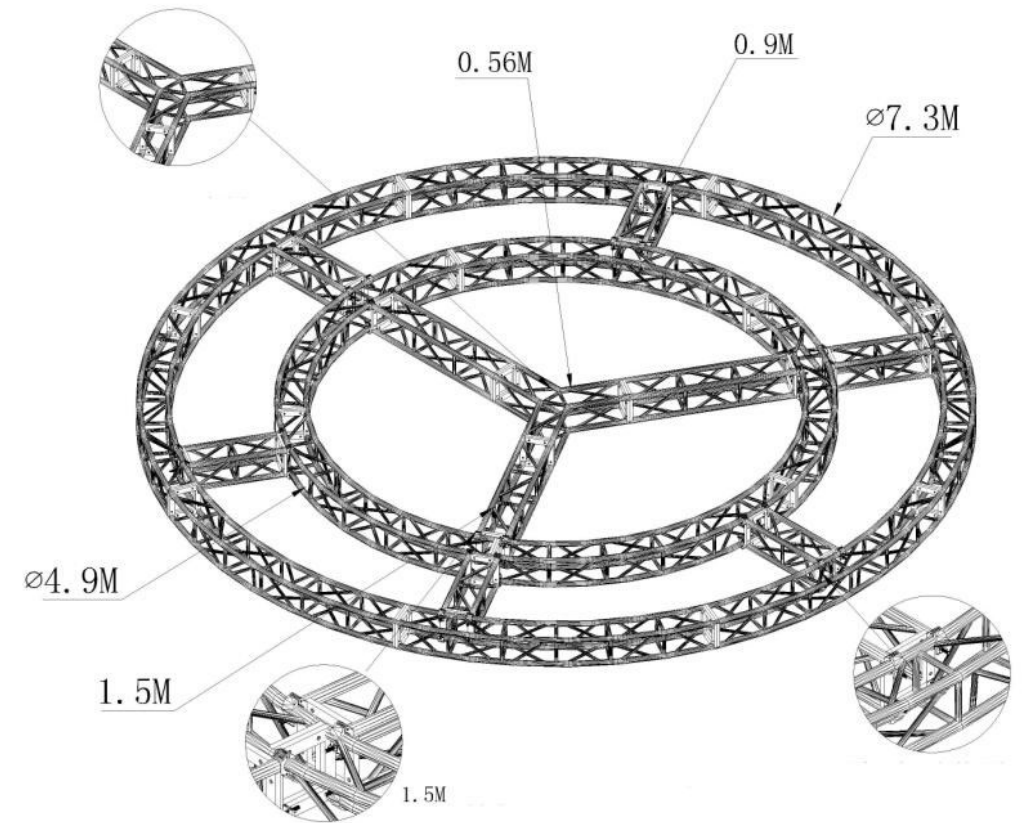

A speaker truss

A speaker truss ,used to hand line array, height H5-10m , within 1T. It could be assemble by normal size truss with the corner base ,top section and adjustable base .

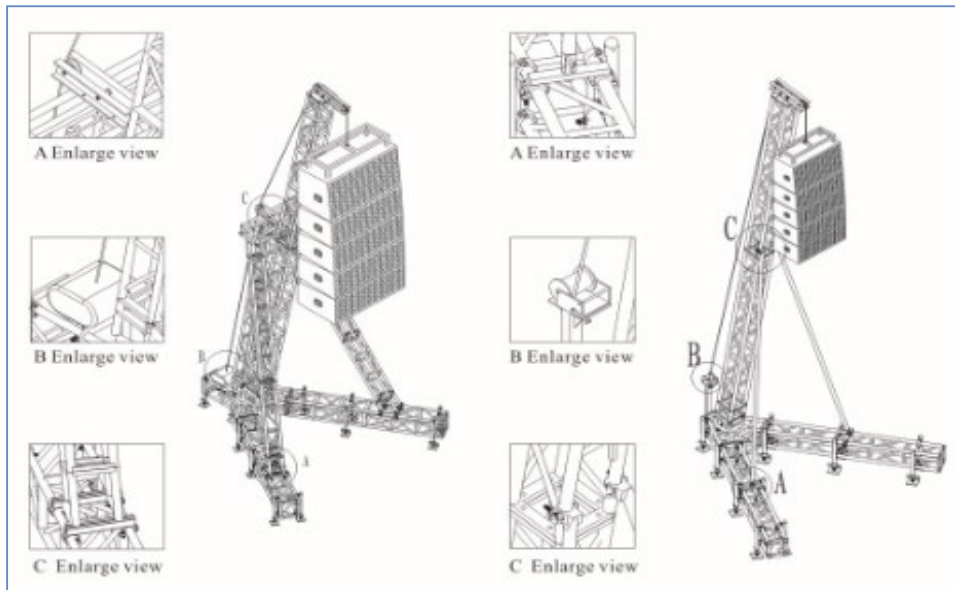
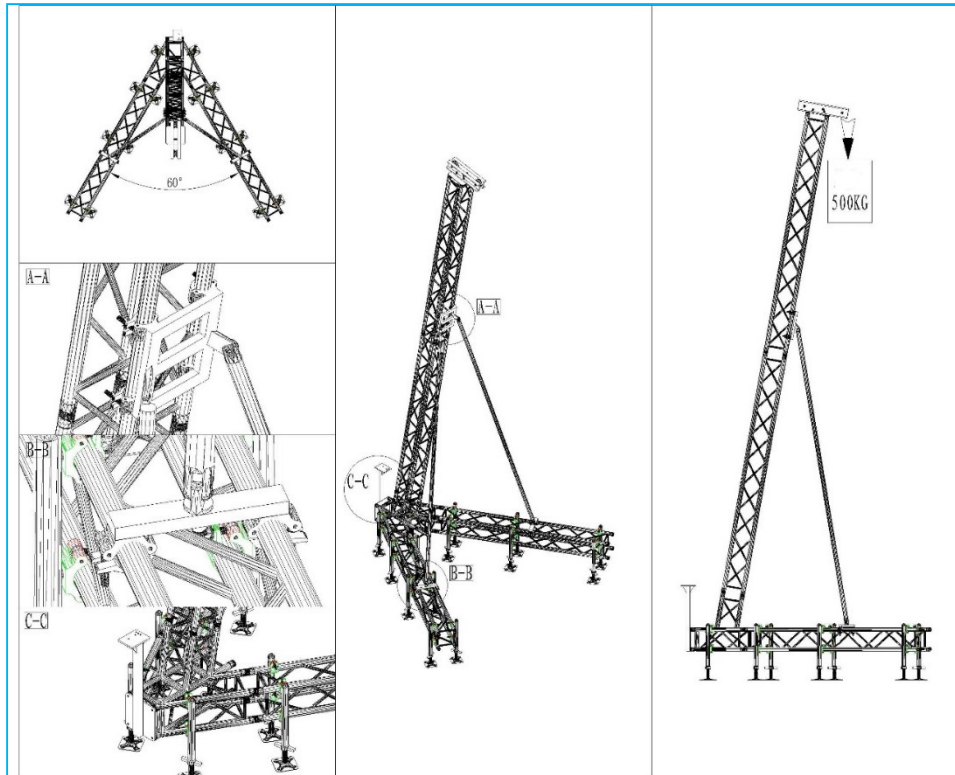

Goalpost for LED screen

Goalpost only two pillars ,it widely used for hanging led screen ,line array and as background truss.

Material: aluminum
Size: flexible size according to span and loading weight needed.

Different structure available

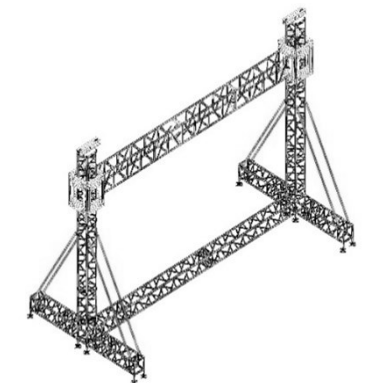
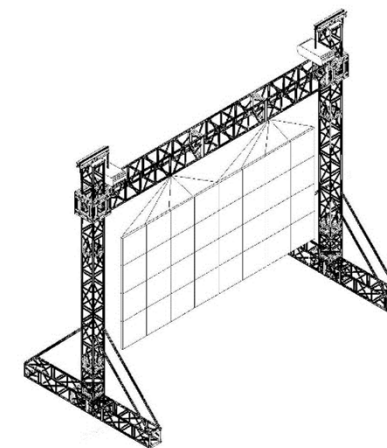
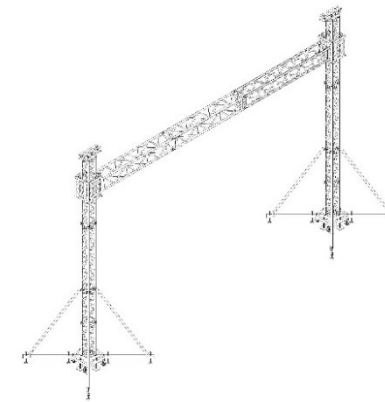

Project truss

Flexible size

Aluminum truss ,made by aluminum 6082, widely used in show , concert ,rental event. structure and size are flexible on span ,loading capability and event effect needed.

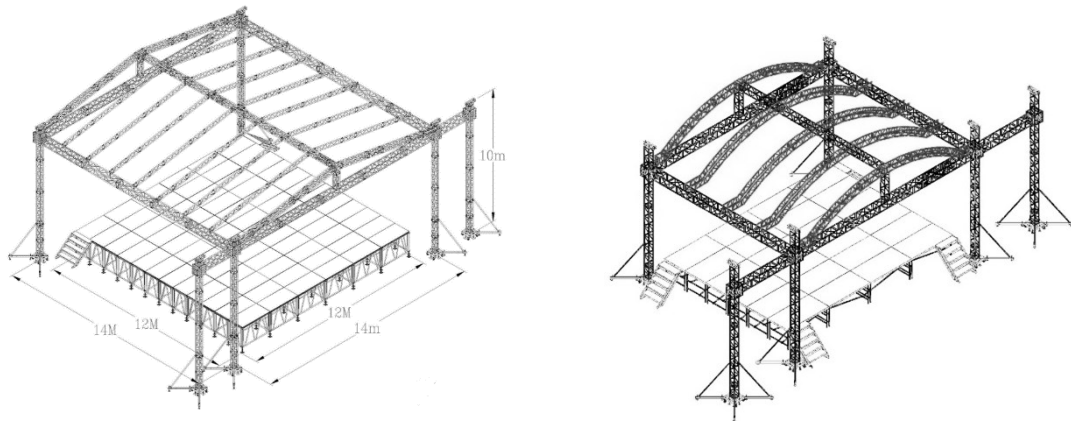

Arc truss system

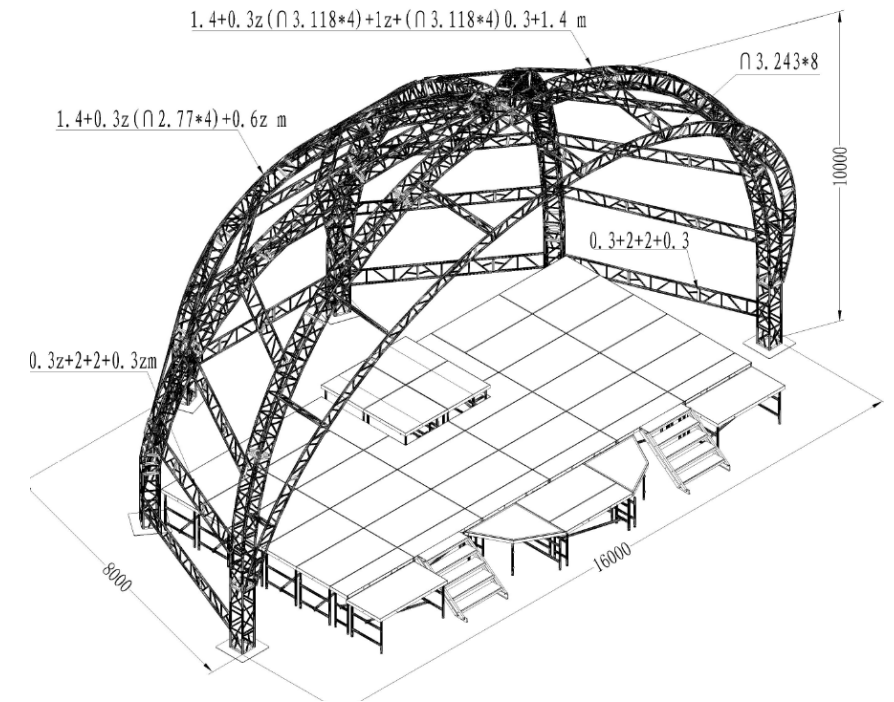

Customer event site



Project accessories

PH001

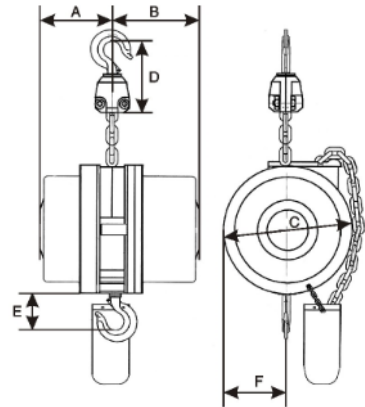

额定负荷 (T) 主要尺寸 (mm)	0.5T	1T	2T
A	130	140	260
B	140	148	285
C	196	236	290
D	120	150	170
E	73	93	105
F	98	118	145



PHC01 hoist control



PHB02 hoist bag

The Main Technical Parameters				
Type	Unit	PH001-0.5T	PH001-1T	PH001-2T
Rated Lifting Capacity	T	0.5	1	2
Lifting Height	m	25	25	25
Lifting Chain	mm	φ6×18	φ8×24	φ11×34
Lifting Speed	m/min	3.2	2.5	2.5
Lifting Motor		YHPE-300S4	YHPE-500S4	YHPE-1100S4
Protection Grade	IP44			
Motor Speed	1380/RPM			
Output Power	50HZ			
Voltage	Triphase:380v/50HZ、415V/50HZ、220V/50HZ 440V/60HZ			
Link Level	Level 80 (The breaking rate is 8 times of the weight)			
Ring Chain Length	24m			
Ring Chain Surface Treatment	Cold galvanized			
Test load	1.25 times of the weight			
Dead Weight (excluding lifting chain)	Kg	15	30	58

Project accessories



PCL001 clamp
SWL 200kg



PCL002 clamp
SWL 250kg



PCL003 clamp
SWL 200kg



PCL004 clamp
SWL 500kg



PCL005 clamp
SWL 35kg



PCL006 clamp
SWL 200kg



PCL007 clamp
SWL 500kg



PCL008 clamp
SWL 500kg



PCL009 ceiling
clamp



PCL010 U shackle
4.75T



PCL011 truss hinge



PCL012 aluminum
Transport



PCL013 coupler
Pin+R spring



PCL014 adjustable
spigot



PCL015 clamp
SWL 200kg



PAC016 steel wire



PAC017 cable



PAC018
cable4X2.5



PAC019 Plug 4X32A
IP67

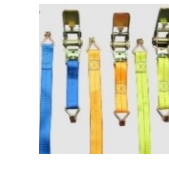

PAC020 Fabric belt
2T 8m



PH002 manual hoist
1.5T 8m chain



PAC021 flight belt
2T 3m



PHB02 hoist bag
H30cm / H45cm



PCP002 cable
protector 2way



PCP005 cable
protector 5 way

Layer truss

Scaffolding

Layer truss(scaffolding) made by 48.3mm steel. 5 parts(base ,base stock, pole, horizontal beam, diagonal corner beam) to assemble They are used a lot in shows. size flexible for line array ,LED screen background, Versatile size and structure available

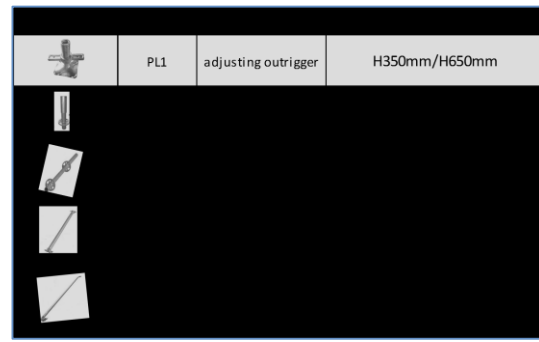
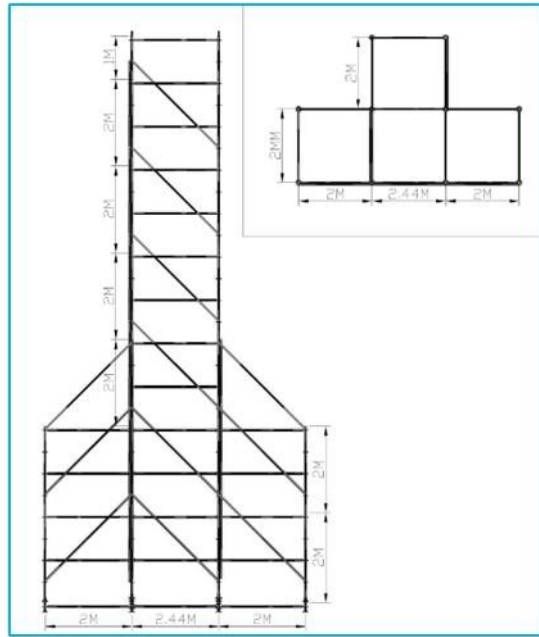

For photograph, size flexible

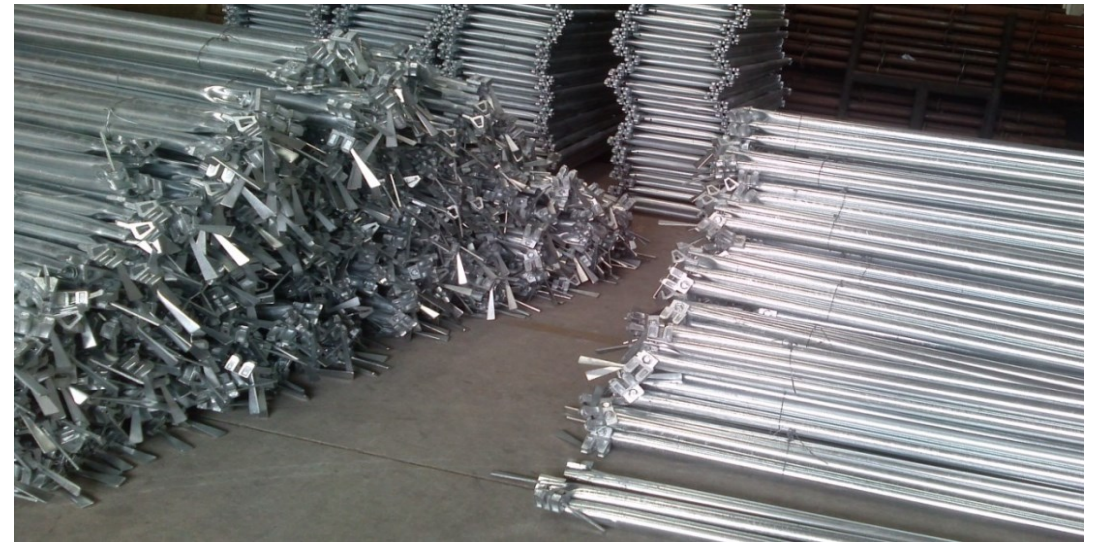
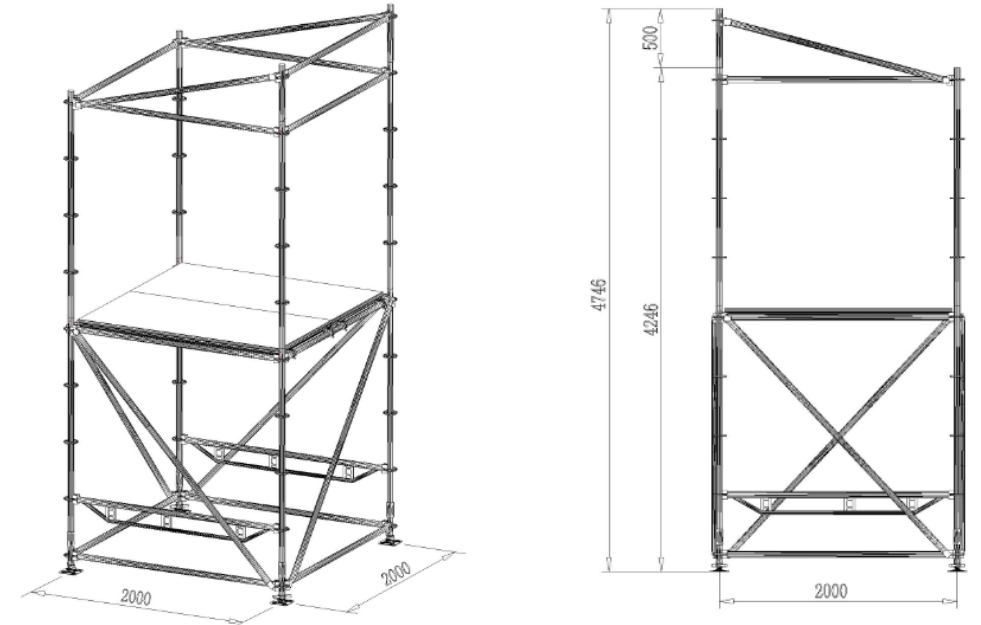

Stage series: we have different kinds of stage to meet customers' need ,and make out the expected effect.

Now there is assemble stage ,adjustable stage ,folding stage according to stage structure.

Every stage would be carefully designed,produced and test builded before delivery to customers.

ST001
Adjustable stage

Size:	1x2m, 1.22x2.44m
Height:	Adjustable height H0.4-0.6m, H0.6-1.0m ,H 0.8-1.2m
Description:	Aluminum mobile stage , adjustable height
Material:	18mm professional stage plywood+H80cm aluminum strong frame(2.5mm)
Loading capability:	550-650kg per sqm
Weight:	62kg
Applications:	Hot mobile stage for indoor and outdoor events

ST002
Mobile folding stage(X stage)

Size:	1x1m, 1X2m
Height:	H0.4m , H0.6m, H0.8m
Description:	Mobile folding stage; X stage
Material:	Aluminum alloy + 5mm plywood
Loading Weight:	280-350kg per sqm
Applications:	Hot folding mobile stage for indoor and outdoor events

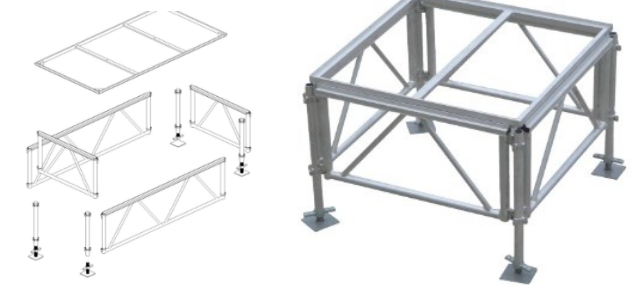
ST003
Aluminum mobile stage

Size:	1.22x1.22m, 1.22x2.44m
Adjustable height:	H0.4-0.6m, H0.6-1.0m ,H 0.8-1.2m ,H1-1.5m
Description:	Aluminum assemble stage ,mobile stage , adjustable height
Material:	18mm professional stage plywood+H80cm aluminum strong frame(2.5mm)
Loading capability:	550-700kg per sqm
Applications:	Hot mobile stage for indoor and outdoor events ,show stage, party stage

ST004

Hotel stage



Size:	1.22x2.44m, 1.83x2.44m
Adjustable height:	H0.41-0.61m, H0.61-0.81m
Description:	Hotel stage ,folding stage, assemble stage ,mobile stage , adjustable height
Material:	18mm professional stage plywood (color choose)
Loading capability:	650-750kg per sqm
Applications:	Hot mobile stage for hotel ,indoor and outdoor events , show stage, party stage

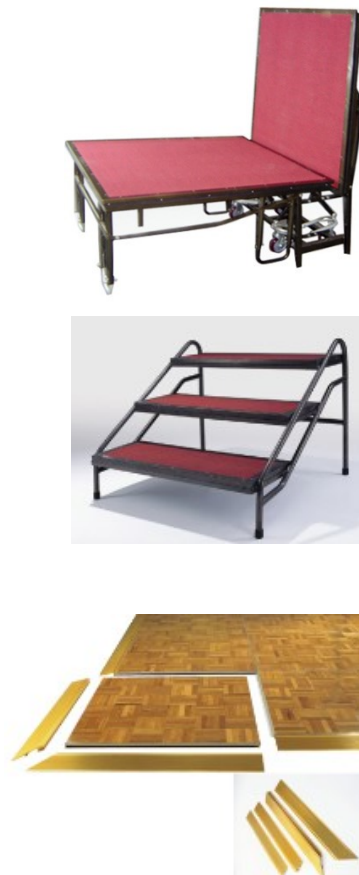
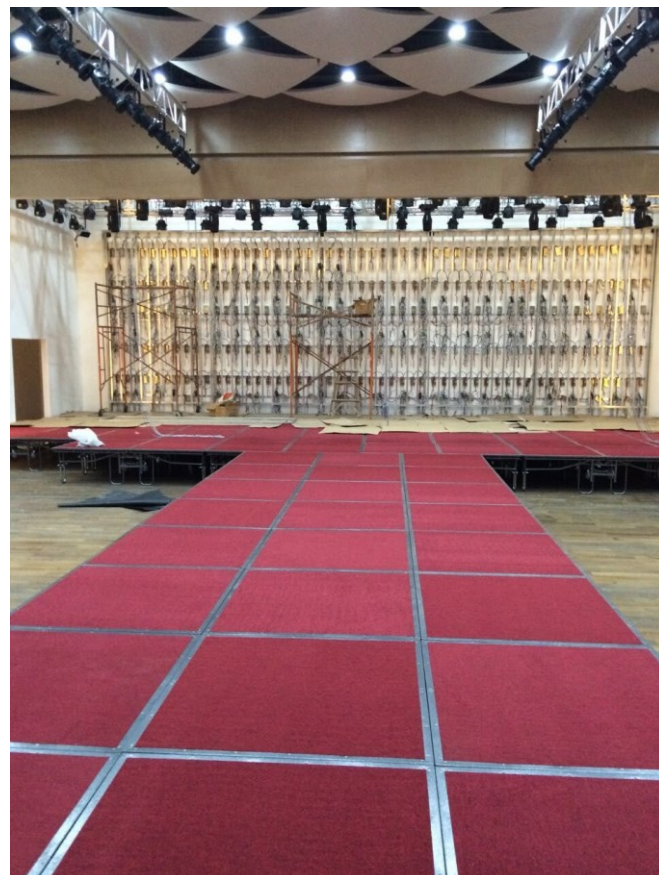

ST005

smart stage



Size:	1x2m
Adjustable height:	H0.4-1m ,1.1-2m
Description:	Hotel folding stage, assemble stage ,mobile stage , adjustable height
Material:	18mm professional stage plywood (black or brown color)
Loading capability:	600-750kg per sqm
Applications:	Hot mobile stage for hotel ,indoor and outdoor events ,show stage, party stage



Workbench

PW-1.4X0.75m/2X1m

Size: L1.4x0.75m / 2x1m

Aluminum workbench features:
Ease and fast speed of erection and dismantling.

Different load capacity by spacing its components differently.
High support loading capacity and flexibility.
Time saving and labor saving.
All parts joint securely by special couplings, system remain stable on uneven ground.
Safe working platform with hook board and ladder.
Rapid cycling use, shorten construction time.
Connection parts with long welding line ensures high shear resistance
Labor and time saving



Details show



Workbench to mauritius





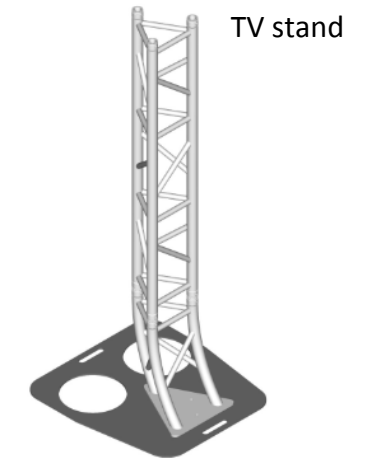
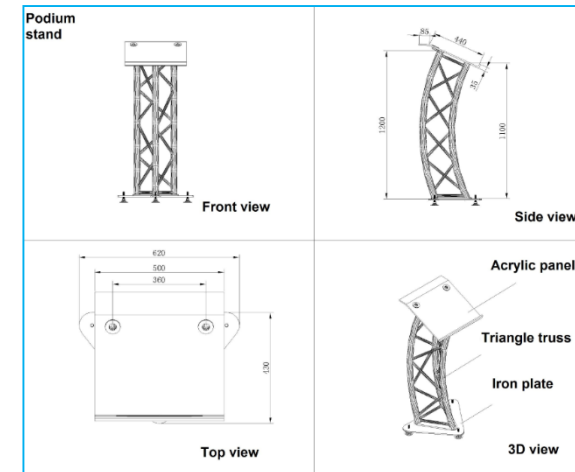





Podium
TV stand

Podium truss stand ,just fixed with base ,and transparent acrylic on top to keep laptop & paper . Easy assemble ,widely used for kinds of event, speech ,meeting room etc.

Adjustable pipe system
Background cloth setup

Cross bar 4-12ft
Telescopic legs 4-12ft
Base plate 450X450mm

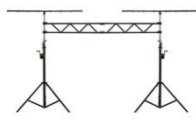

<p>PT001</p> <p>Name: 6m new truss stand Height: 2.1-6M Shelf weight: 125KG SWL: 250KG Base size: 470X470mm</p> 	<p>PT003</p> <p>Name: 6.5m heavy-duty truss stand Height: 2-6.5M Shelf weight: 95KG SWL: 200KG Base size: 470X470 mm</p> 
<p>PCA005</p> <p>Name: 5.5m heavy-duty truss stand Height: 2-5.5M Shelf weight: 80KG SWL: 150KG Base size: 450X450mm</p> 	<p>PCA023</p> <p>Name: 6.5m new truss stand with wheels H: 2-6.5M Shelf weight: 99KG SLW: 200KG base size: 460X460 mm</p> 
<p>PCA007</p> <p>Name:4m single beam H: 1.7-4M , 8 holes Beam:2m,thickness 1.5mm Shelf weight: 24KG SWL:50-60KG</p> 	<p>PCA008</p> <p>Name:4m double beam H: 1.7—4M , 16 holes Beam:2m,thickness 1.5mm Shelf weight: 27KG SWL:50-60KG</p> 
<p>PCA009</p> <p>Name:3m single beam H: 1.2-3M , 8 holes Beam:1.5m,thickness 1.5mm Shelf weight: 18KG SWL:50-60KG</p> 	<p>PCA010</p> <p>Name:3m double beam stand H: 1.2—3M 12 holes Beam:1.5m ,thickness 1.5mm Shelf weight:20KG SWL:50-60KG</p> 
<p>PCA017</p> <p>Name: handwich stand H: 1.7—4M middle ladder 3m Shelf weight: 56KG SWL: 100KG</p> 	<p>PCA018</p> <p>Name: double beam stand H: 1.58-2.8M Shelf weight: 12.5KG SWL: 30-50KG</p> 

Crowd Barrier
Event barrier , customized

Use for indoor and outdoor big event for security.
Size:L100cmXD124cmxH120cm
Weight:25.3kgs

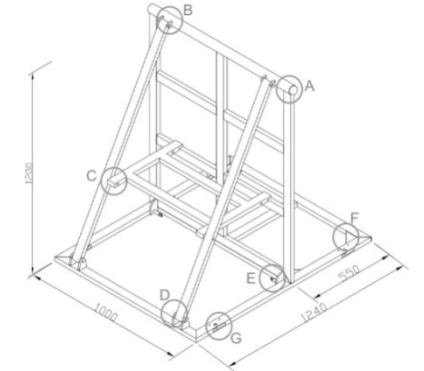

Stage Machinery

Rotating stage

Scenic effects involving rotating turntables, tracking stage wagons, and the vertical movement of curtains and painted drops have become common in both Broadway and regional theatre productions. we have good experience on mechanical stage according to customer's.

Below is the mechanical stage ,2 layer rotating (forward and reversal rotating), whole one could be move forward and backward also . for Tsinghua university prince igor opera show .

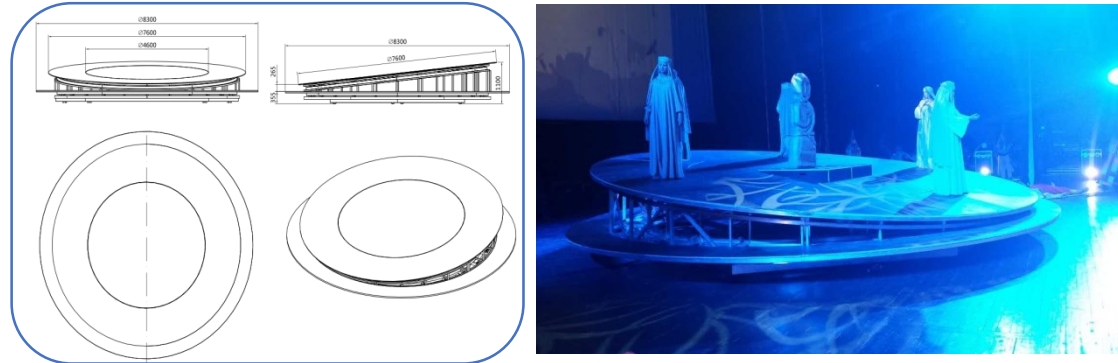

Slip track

Slip track for background ,LED screen close and open or special stage effect needed.

Size customized .

Material: aluminum or steels

Loading Weight:300-500kgs

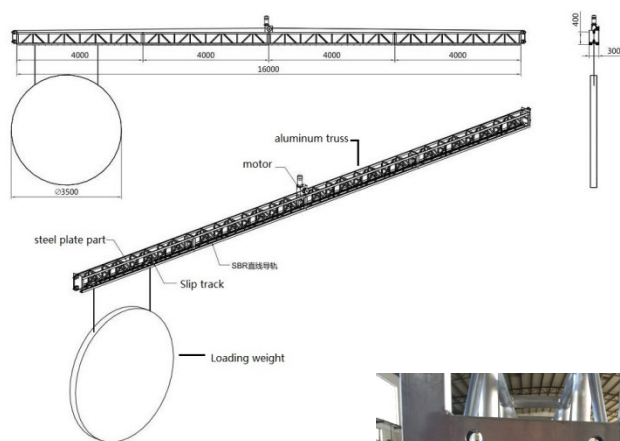

Tent

Pagoda

Different size tent and pagoda are available for outdoor event ,party ,sports .

Size :25X50m white color

Eave height 6m

Ridge height 9.96m

Bay distance 5m

Main frame profile size

112x203x4mm(four channels)

Including aluminum frame , roof covering ,, wall with windows ,flexible wall height 4m or 6m .

Accessories:

Frame:reinforced aluminum frame 6061 T6 surface annodized finished

Cover: double pvc coated polyester ,850g/sqm, block-out , water-proof, UV resistant retardant . Sidewall: Double pvc coated polyester 650g/sqm, translucent water-proof ,UV resistant . connector: hot dipped galavanized steel

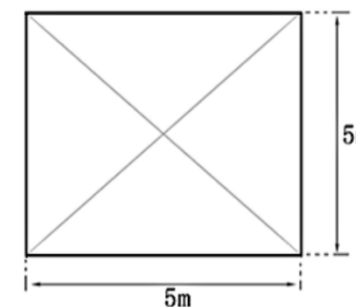
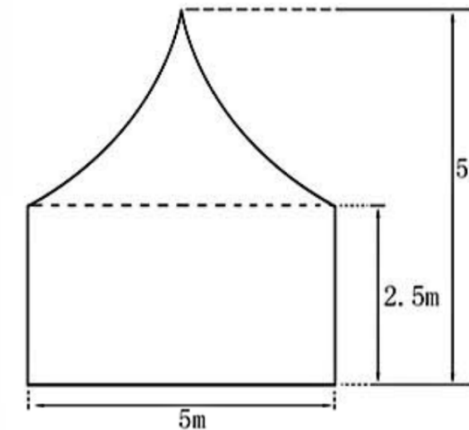
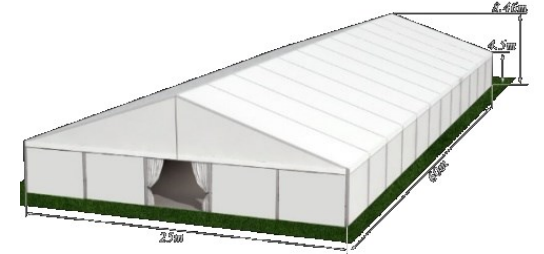

Main Profiles:	Available sizes:63mx63m x2mm ,122mm x68mm x3mm Material: Hard pressed extruded Aluminum alloy T6061/T6
Cover:	Features: steelless
	Density: 850g/sqm block-out white PVC for roof 650g/sqm translucent white PVC for side walls
	Material :PVC coated polyester fabric Features: water proof ,UV resistance, fire retardant(DIN4102,B1,M2)
Components:	Superior enclosure with hot dip galvanized steel